

Taper roller bearings, single row

Principal dimensions			Basic load ratings		Fatigue load limit Pu	Speed ratings		Mass	Designation
d	D	T	dynamic	static		Reference speed	Limiting speed		
mm			kN		kN	r/min		kg	* - SKF Explorer bearing
110	200	41	308	405	45	2400	3200	5,10	30222 J2

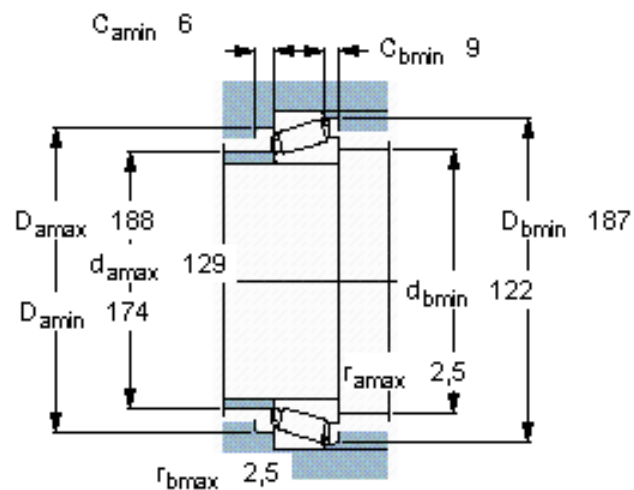
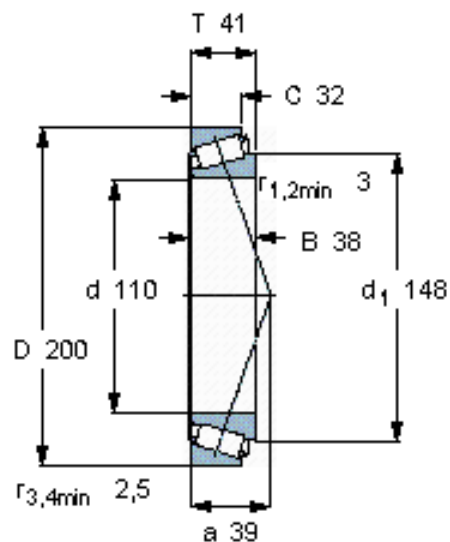

Calculation factors

e 0,43
 $\gamma 1,4$
 $\gamma_0 0,8$