

### Taper roller bearings, single row

Principal dimensions			Basic load ratings		Fatigue load limit Pu	Speed ratings		Mass	Designation
d	D	T	dynamic	static		Reference speed	Limiting speed		
mm			kN		kN	r/min		kg	* - SKF Explorer bearing
170	310	57	616	865	83	1500	2000	19,0	30234 J2

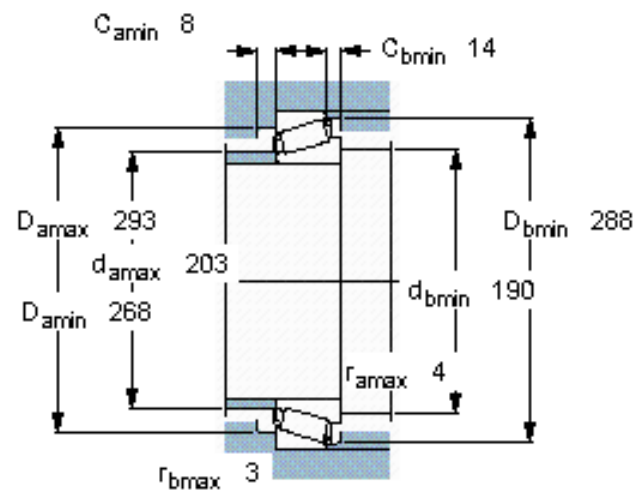
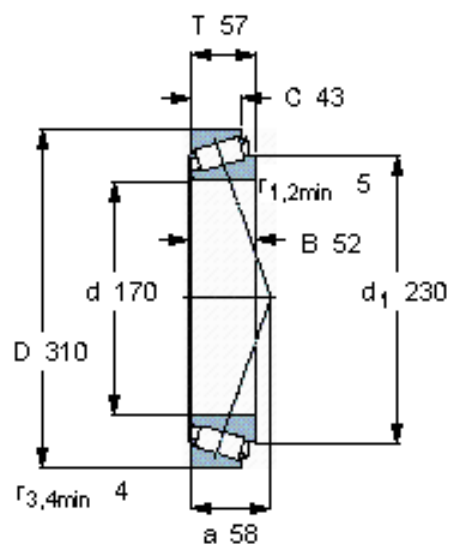

#### Calculation factors

e 0,43

Y 1,4

$Y_0$  0,8