

### Taper roller bearings, single row

Principal dimensions			Basic load ratings		Fatigue load limit Pu	Speed ratings		Mass	Designation
d	D	T	dynamic	static		Reference speed	Limiting speed		
mm			kN		kN	r/min		kg	* - SKF Explorer bearing
45	100	27,25	108	120	14,3	5300	7000	0,97	30309 J2/Q

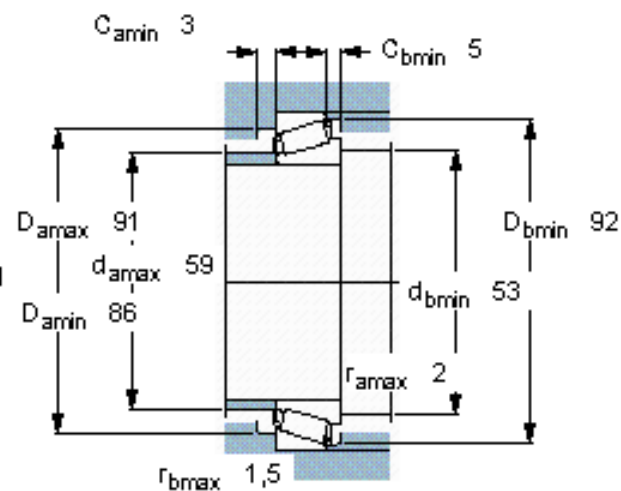
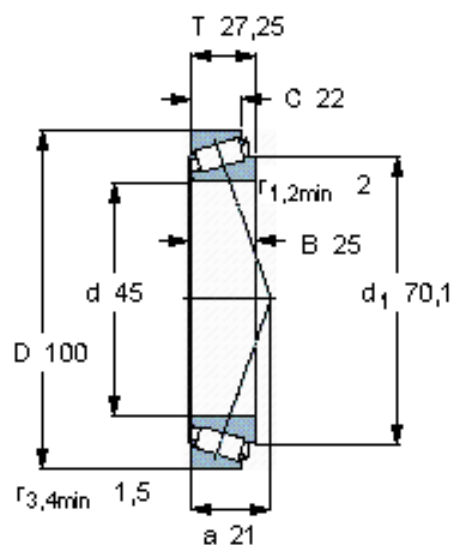

#### Calculation factors

e 0,35  
 $\gamma 1,7$   
 $\gamma_0 0,9$