

Taper roller bearings, single row

Principal dimensions			Basic load ratings		Fatigue load limit Pu	Speed ratings		Mass	Designation
d	D	T	dynamic	static		Reference speed	Limiting speed		
mm			kN		kN	r/min		kg	* - SKF Explorer bearing
75	160	40	246	290	34	3200	4300	3,45	30315 J2/Q

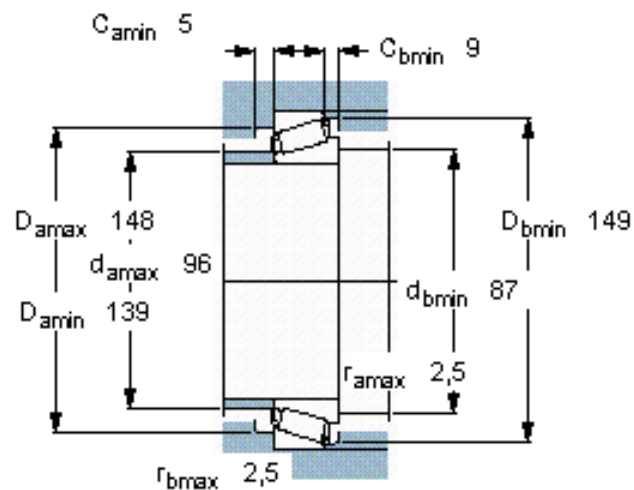
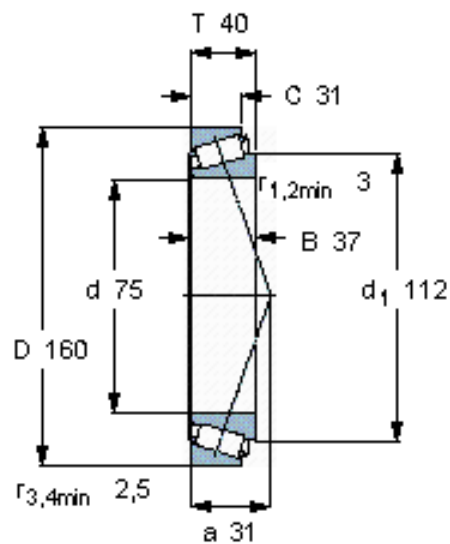

Calculation factors

e 0,35
 $\gamma 1,7$
 $\gamma_0 0,9$