

Taper roller bearings, single row

Principal dimensions			Basic load ratings		Fatigue load limit Pu	Speed ratings		Mass	Designation
d	D	T	dynamic	static		Reference speed	Limiting speed		
mm			kN		kN	r/min		kg	* - SKF Explorer bearing
80	170	42,5	270	320	38	3000	4300	4,10	30316 J2

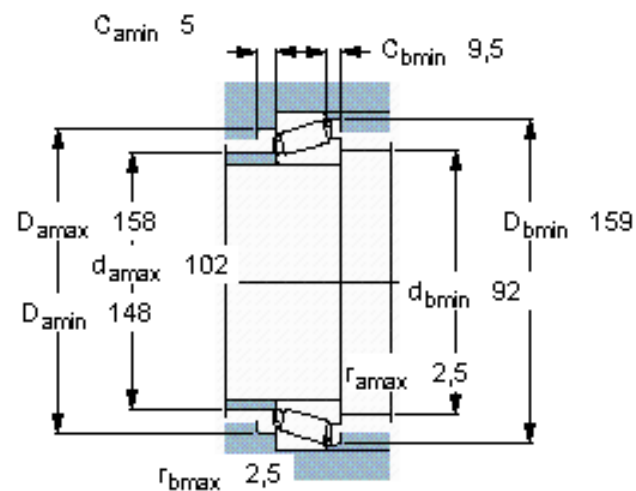
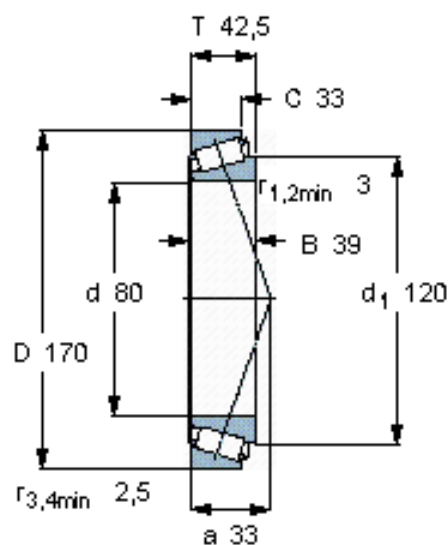

Calculation factors

e 0,35

Y 1,7

Y_0 0,9