

Taper roller bearings, single row

Principal dimensions			Basic load ratings		Fatigue load limit Pu	Speed ratings		Mass	Designation
d	D	T	dynamic	static		Reference speed	Limiting speed		
mm			kN		kN	r/min		kg	* - SKF Explorer bearing
90	190	46,5	330	400	44	2600	4000	5,65	30318 J2

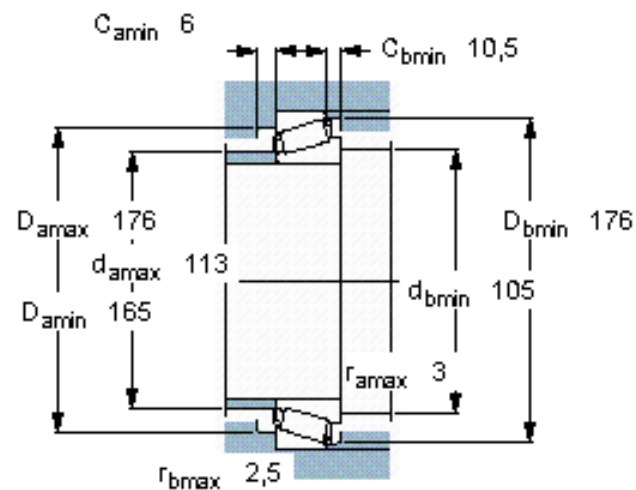
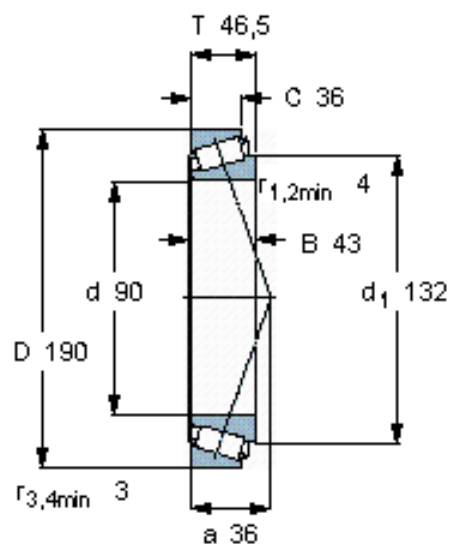

Calculation factors

e 0,35
 γ 1,7
 γ_0 0,9