

Taper roller bearings, single row

Principal dimensions			Basic load ratings		Fatigue load limit Pu	Speed ratings		Mass	Designation
d	D	T	dynamic	static		Reference speed	Limiting speed		
mm			kN		kN	r/min		kg	* - SKF Explorer bearing
95	200	49,5	292	355	39	2400	3400	6,95	31319 J2

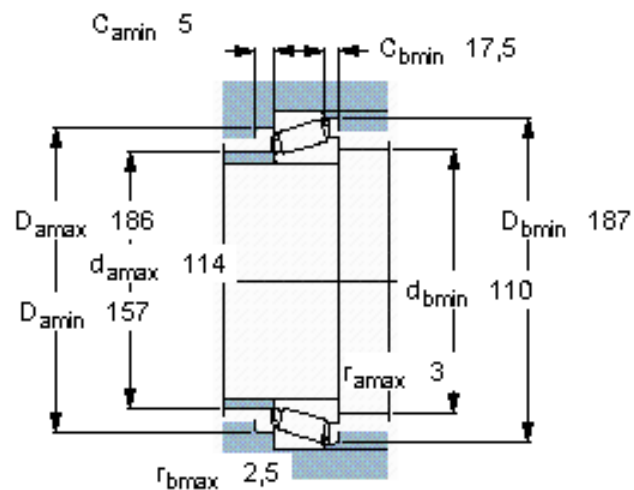
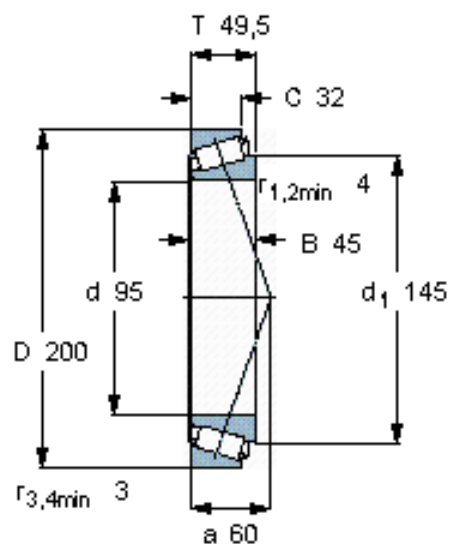

Calculation factors

e 0,83

Y 0,72

Y_0 0,4