

Taper roller bearings, single row

| Principal dimensions | | | Basic load ratings | | Fatigue load limit Pu | Speed ratings | | Mass | Designation |
|----------------------|-----|----|--------------------|--------|--------------------------|-----------------|----------------|------|--------------------------|
| d | D | T | dynamic | static | | Reference speed | Limiting speed | | |
| mm | | | kN | | kN | r/min | | kg | * - SKF Explorer bearing |
| 110 | 170 | 38 | 233 | 390 | 42,5 | 2600 | 3600 | 3,05 | 32022 X/Q |

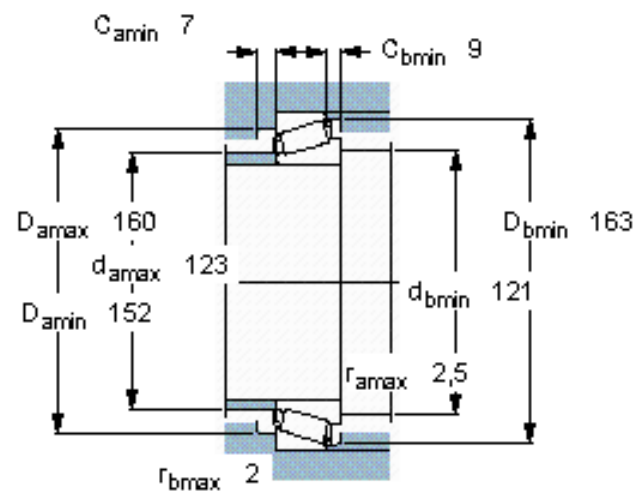
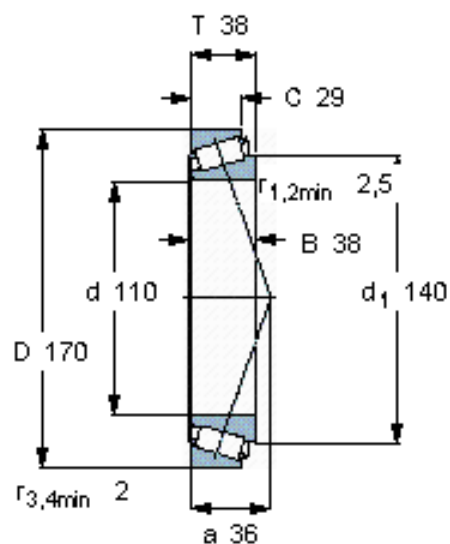

Calculation factors

e 0,43

Y 1,4

$Y_0 0,8$