

### Taper roller bearings, single row

Principal dimensions			Basic load ratings		Fatigue load limit Pu	Speed ratings		Mass	Designation
d	D	T	dynamic	static		Reference speed	Limiting speed		
mm			kN		kN	r/min		kg	* - SKF Explorer bearing
130	200	45	314	540	55	2200	3000	4,95	32026 X

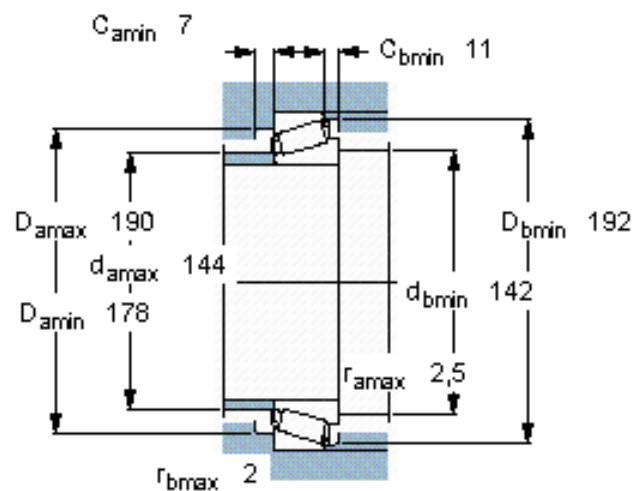
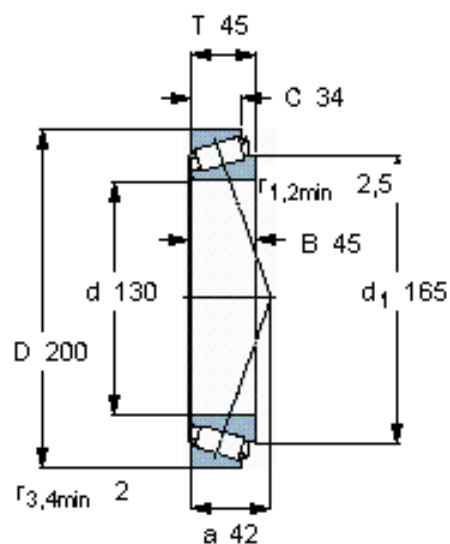

#### Calculation factors

e 0,43  
Y 1,4  
Y<sub>0</sub> 0,8