

Taper roller bearings, single row

Principal dimensions			Basic load ratings		Fatigue load limit Pu	Speed ratings		Mass	Designation
d	D	T	dynamic	static		Reference speed	Limiting speed		
mm			kN		kN	r/min		kg	* - SKF Explorer bearing
85	150	38,5	212	285	33,5	3200	4300	2,60	32217 J2/Q

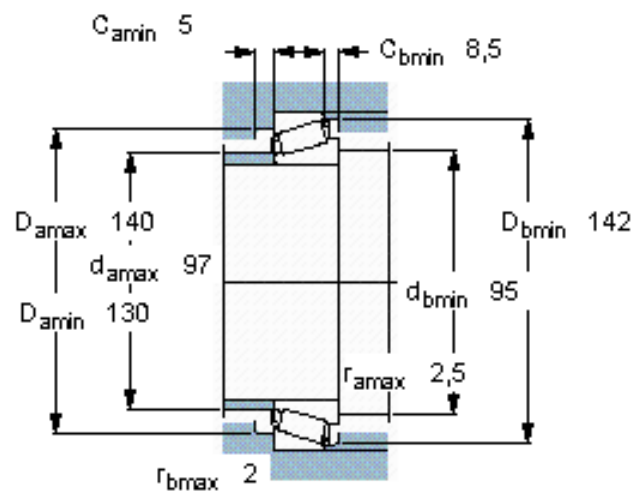
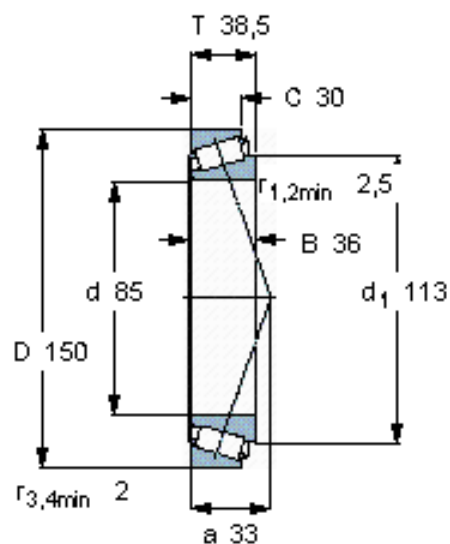

Calculation factors

e 0,43

Y 1,4

Y_0 0,8