

Taper roller bearings, single row

Principal dimensions			Basic load ratings		Fatigue load limit Pu	Speed ratings		Mass	Designation
d	D	T	dynamic	static		Reference speed	Limiting speed		
mm			kN		kN	r/min		kg	* - SKF Explorer bearing
105	160	43	246	430	45,5	2800	3800	3,05	33021/Q

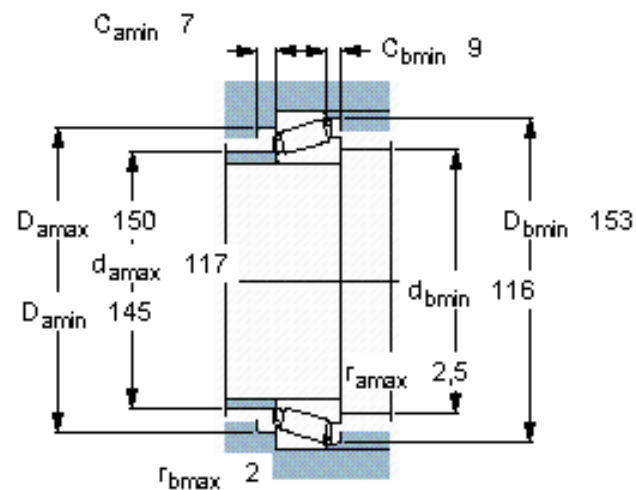
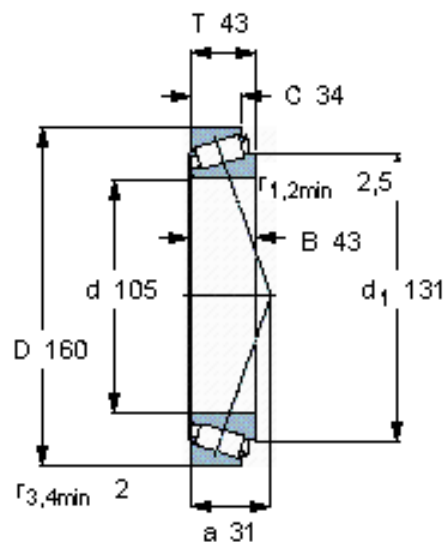

Calculation factors

e 0,28

Y 2,1

$Y_0 1,1$