

Spherical roller bearings, cylindrical and tapered bore

Principal dimensions			Basic load ratings		Fatigue load limit Pu	Speed ratings		Mass	Designation
d	D	B	dynamic	static		Reference speed	Limiting speed		
mm			kN		kN	r/min		kg	-
30	62	20	64	60	6,4	10000	14000	0,29	22206 E *

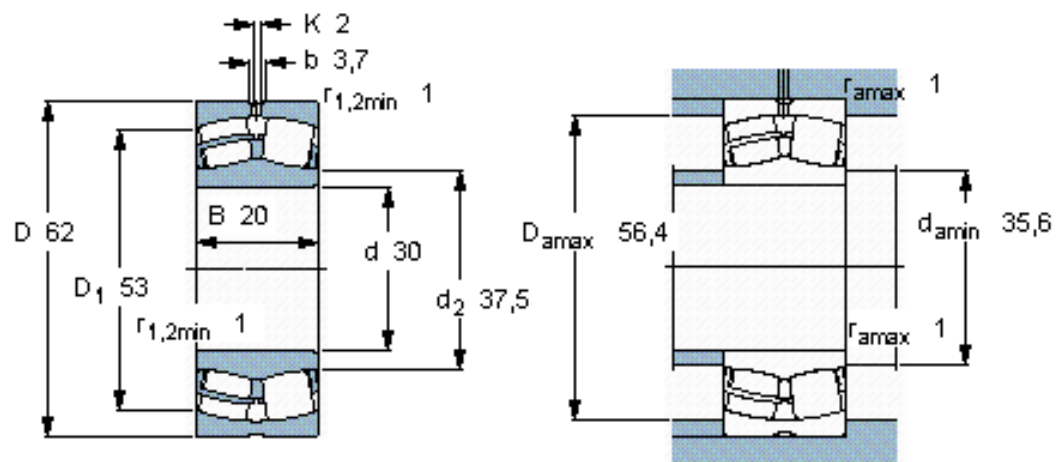

Calculation factors

e 0,31
 Y_1 2,2
 Y_2 3,3
 Y_0 2,2