

Spherical roller bearings, cylindrical and tapered bore

Principal dimensions			Basic load ratings		Fatigue load limit Pu	Speed ratings		Mass	Designation
d	D	B	dynamic	static		Reference speed	Limiting speed		
mm			kN		kN	r/min		kg	-
85	150	36	285	325	34,5	4000	5600	2,65	22217 E *

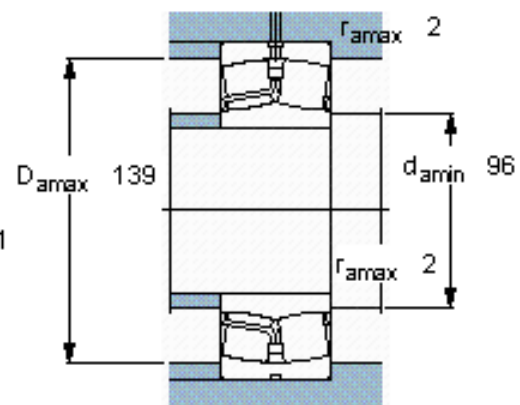
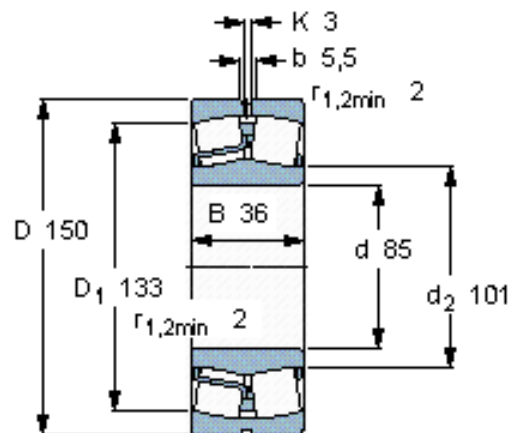

Calculation factors

$e = 0,22$
 $Y_1 = 3$
 $Y_2 = 4,6$
 $Y_0 = 2,8$