

Spherical roller bearings, cylindrical and tapered bore

Principal dimensions			Basic load ratings		Fatigue load limit Pu	Speed ratings		Mass kg	Designation
d	D	B	dynamic	static		Reference speed	Limiting speed		
mm			kN		kN	r/min			* - SKF Explorer bearing
95	170	43	380	450	46,5	3600	4800	4,05	22219 EK *

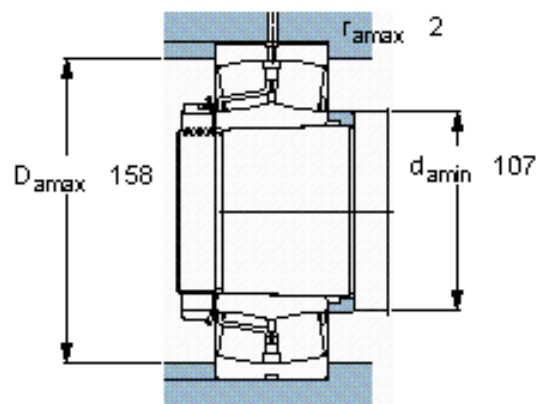
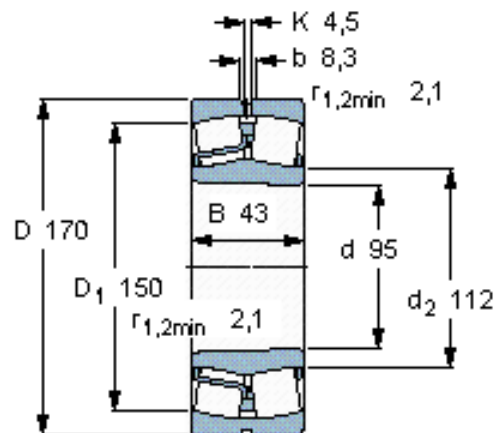

Calculation factors

e 0,24
 Y_1 2,8
 Y_2 4,2
 Y_0 2,8