

Spherical roller bearings, cylindrical and tapered bore

Principal dimensions			Basic load ratings		Fatigue load limit Pu	Speed ratings		Mass	Designation
d	D	B	dynamic	static		Reference speed	Limiting speed		
mm			kN		kN	r/min		kg	-
100	180	46	425	490	49	3400	4500	4,80	22220 EK *

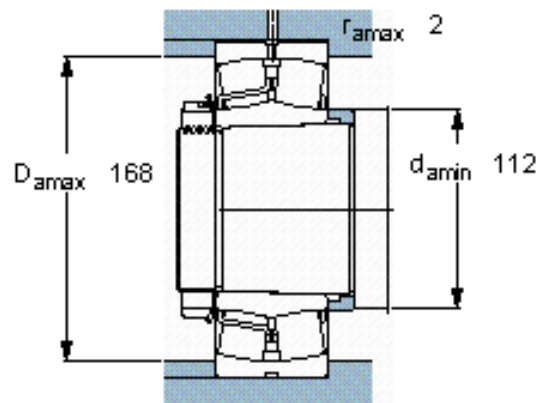
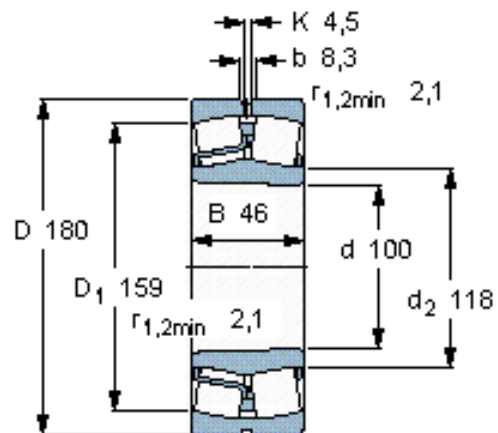

Calculation factors

e 0,24
 Y_1 2,8
 Y_2 4,2
 Y_0 2,8