

Spherical roller bearings, cylindrical and tapered bore

Principal dimensions			Basic load ratings		Fatigue load limit Pu	Speed ratings		Mass	Designation
d	D	B	dynamic	static		Reference speed	Limiting speed		
mm			kN		kN	r/min		kg	-
120	215	58	630	765	73,5	2800	3800	8,70	22224 E *

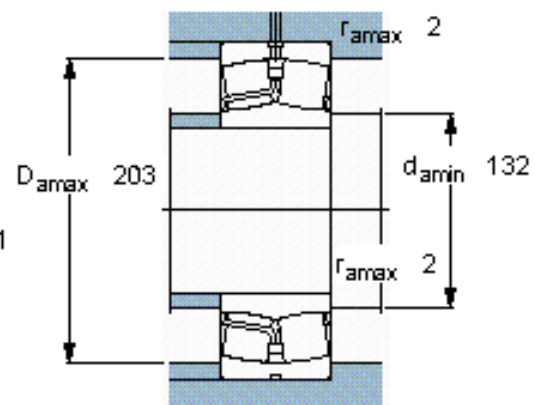
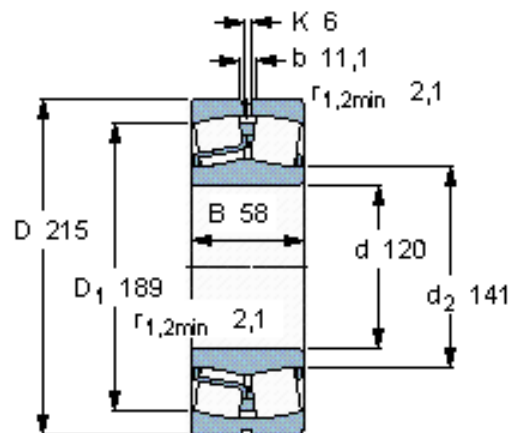

Calculation factors

e 0,26
 Y_1 2,6
 Y_2 3,9
 Y_0 2,5