

Spherical roller bearings, cylindrical and tapered bore

Principal dimensions			Basic load ratings		Fatigue load limit Pu	Speed ratings		Mass	Designation
d	D	B	dynamic	static		Reference speed	Limiting speed		
mm			kN		kN	r/min		kg	-
80	170	58	490	540	54	3000	4000	6,60	22316 E *

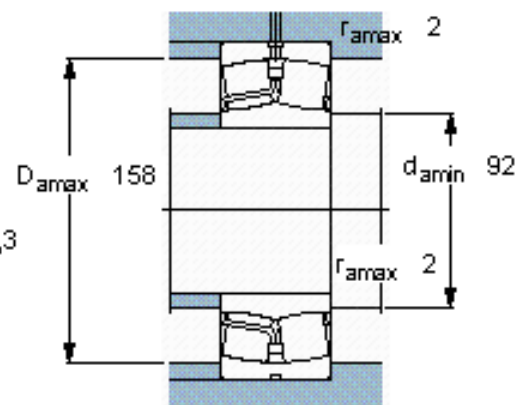
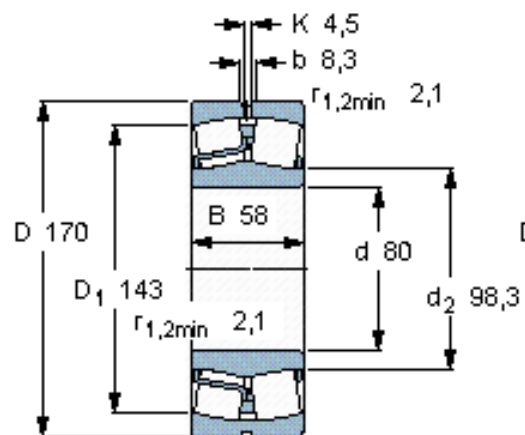

Calculation factors

e 0,35
 Y_1 1,9
 Y_2 2,9
 Y_0 1,8