

Spherical roller bearings, cylindrical and tapered bore

Principal dimensions			Basic load ratings		Fatigue load limit Pu	Speed ratings		Mass	Designation
d	D	B	dynamic	static		Reference speed	Limiting speed		
mm			kN		kN	r/min		kg	-
85	180	60	550	620	61	2800	3800	7,65	22317 E *

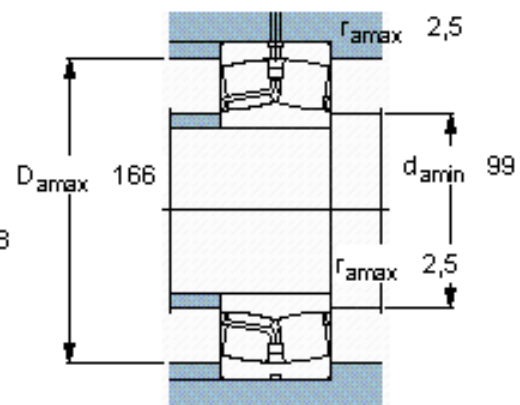
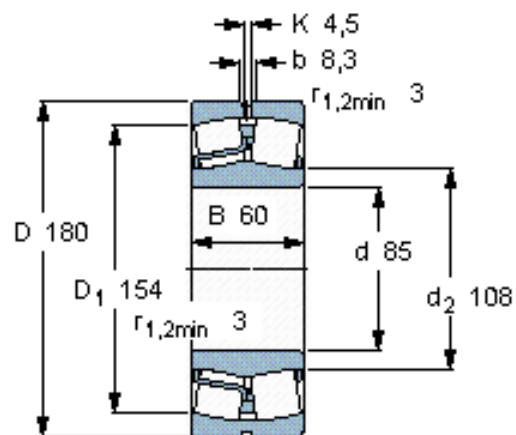

Calculation factors

e 0,33
 Y_1 2
 Y_2 3
 Y_0 2