

Spherical roller bearings, cylindrical and tapered bore

Principal dimensions			Basic load ratings		Fatigue load limit Pu	Speed ratings		Mass	Designation
d	D	B	dynamic	static		Reference speed	Limiting speed		
mm			kN	C0	kN	r/min	kg		* - SKF Explorer bearing
160	340	114	1600	1960	160	1500	1900	52,0	22332 CC/W33 *

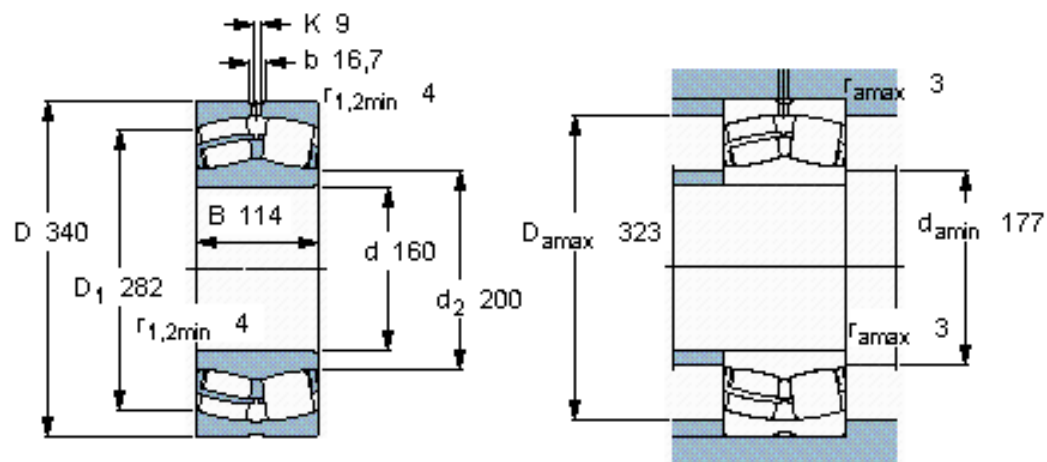

Calculation factors

e 0,35
 Y₁ 1,9
 Y₂ 2,9
 Y₀ 1,8