

Spherical roller bearings, cylindrical and tapered bore

Principal dimensions			Basic load ratings		Fatigue load limit Pu	Speed ratings		Mass kg	Designation
d	D	B	dynamic	static		Reference speed	Limiting speed		
mm			kN	C0	kN	r/min			* - SKF Explorer bearing
220	460	145	2700	3450	260	1000	1400	120	22344 CC/W33 *

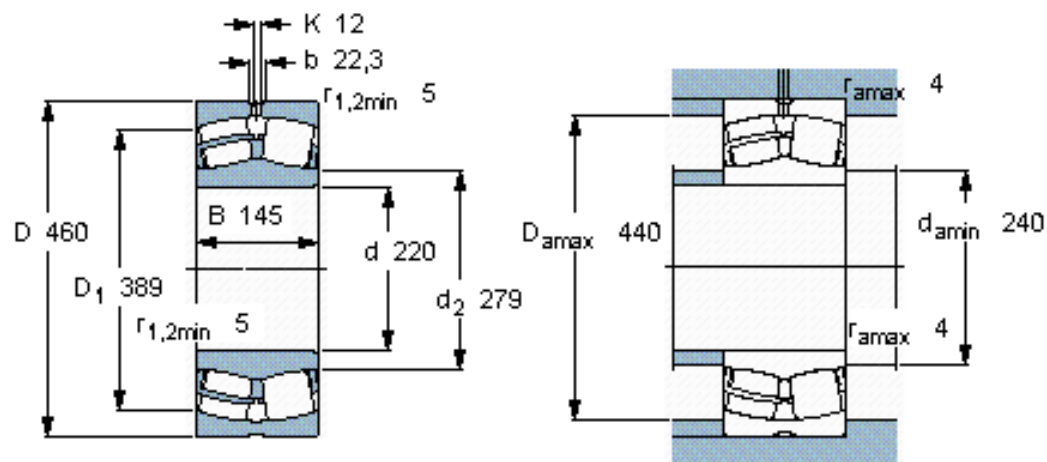

Calculation factors

e 0,31
 Y_1 2,2
 Y_2 3,3
 Y_0 2,2