

### Spherical roller bearings, cylindrical and tapered bore

Principal dimensions			Basic load ratings		Fatigue load limit Pu	Speed ratings		Mass	Designation
d	D	B	dynamic	static		Reference speed	Limiting speed		
mm			kN		kN	r/min		kg	-
240	500	155	3100	4000	290	950	1300	155	22348 CC/W33 *

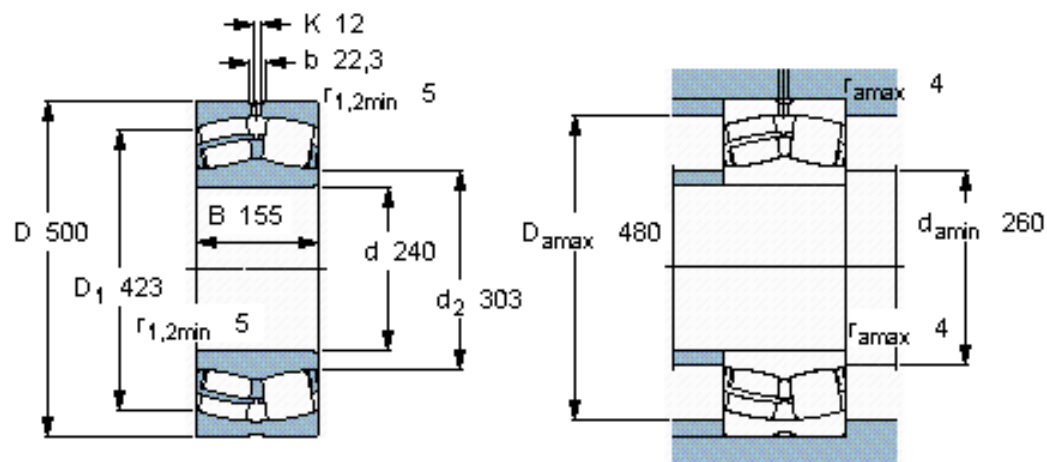

#### Calculation factors

$e = 0,31$   
 $Y_1 = 2,2$   
 $Y_2 = 3,3$   
 $Y_0 = 2,2$