

Spherical roller bearings, cylindrical and tapered bore

Principal dimensions			Basic load ratings		Fatigue load limit Pu	Speed ratings		Mass	Designation
d	D	B	dynamic	static		Reference speed	Limiting speed		
mm			kN		kN	r/min		kg	-
180	300	96	1200	1760	160	1700	2200	28,0	23136 CC/W33 *

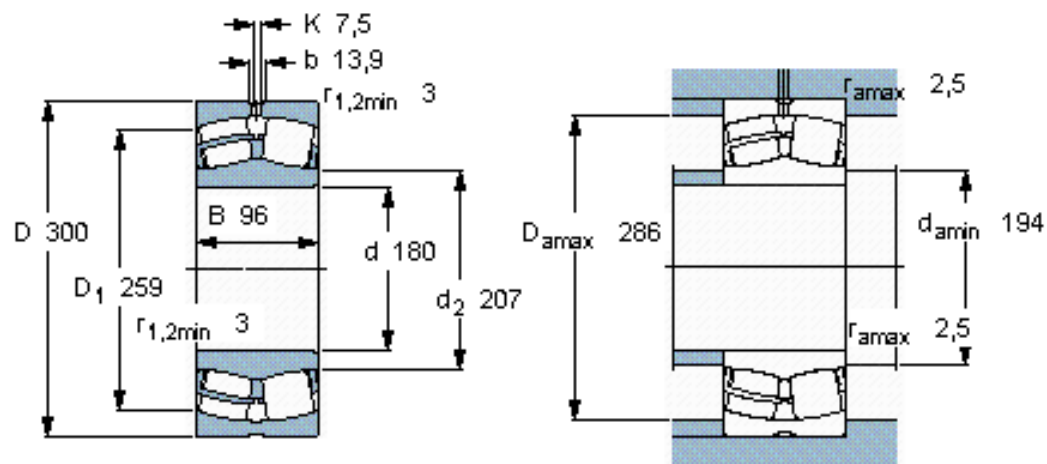

Calculation factors

e 0,30
 Y_1 2,3
 Y_2 3,4
 Y_0 2,2