

Spherical roller bearings, cylindrical and tapered bore

Principal dimensions			Basic load ratings		Fatigue load limit Pu	Speed ratings		Mass	Designation
d	D	B	dynamic	static		Reference speed	Limiting speed		
mm			kN		kN	r/min		kg	-
160	240	80	750	1200	114	1700	2400	13,0	24032 CC/W33 *

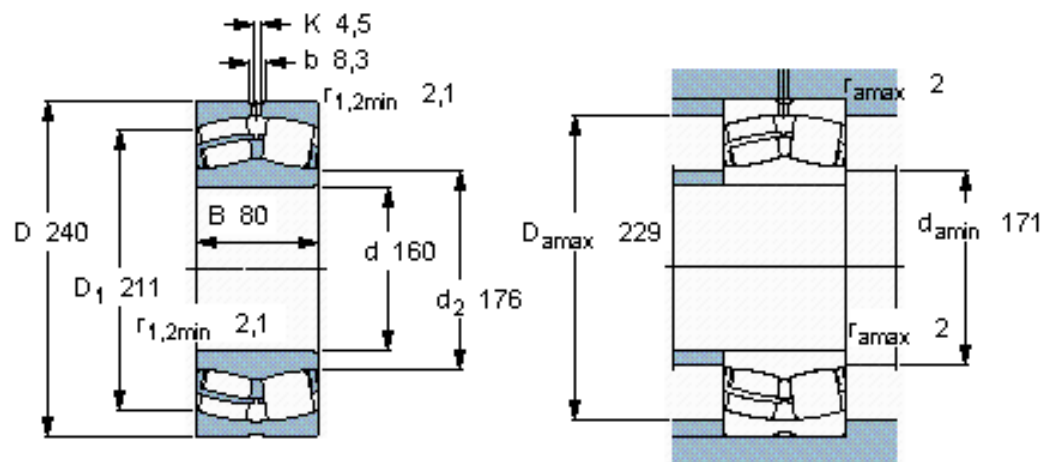

Calculation factors

$e = 0,30$
 $Y_1 = 2,3$
 $Y_2 = 3,4$
 $Y_0 = 2,2$