

Spherical roller bearings, cylindrical and tapered bore

Principal dimensions			Basic load ratings		Fatigue load limit Pu	Speed ratings		Mass	Designation
d	D	B	dynamic	static		Reference speed	Limiting speed		
mm			kN		kN	r/min		kg	-
320	480	160	2850	5100	400	800	1200	100	24064 CC/W33 *

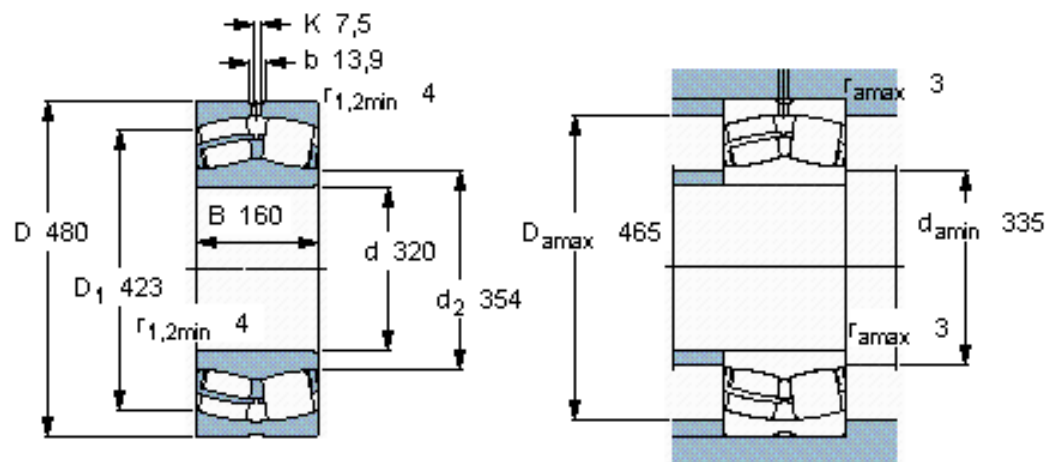

Calculation factors

e 0,31
 Y_1 2,2
 Y_2 3,3
 Y_0 2,2