

Spherical roller bearings, cylindrical and tapered bore

Principal dimensions			Basic load ratings		Fatigue load limit Pu	Speed ratings		Mass	Designation
d	D	B	dynamic	static		Reference speed	Limiting speed		
mm			kN		kN	r/min		kg	-
120	200	80	655	950	95	1900	2600	10,3	24124 CC/W33 *

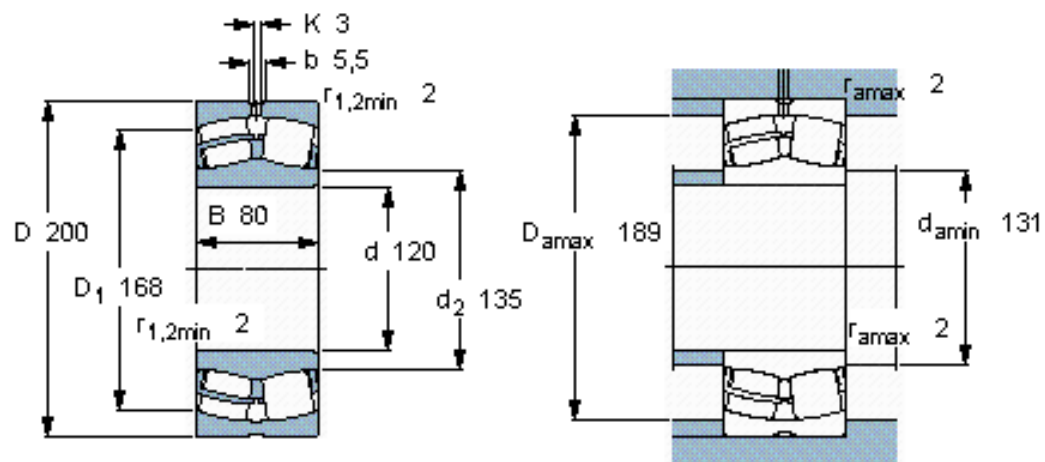

Calculation factors

$e = 0,37$
 $Y_1 = 1,8$
 $Y_2 = 2,7$
 $Y_0 = 1,8$