

### Spherical roller bearings, cylindrical and tapered bore

Principal dimensions			Basic load ratings		Fatigue load limit Pu	Speed ratings		Mass	Designation
d	D	B	dynamic	static		Reference speed	Limiting speed		
mm			kN		kN	r/min		kg	-
320	540	218	4250	7100	510	670	900	210	24164 CC/W33 *

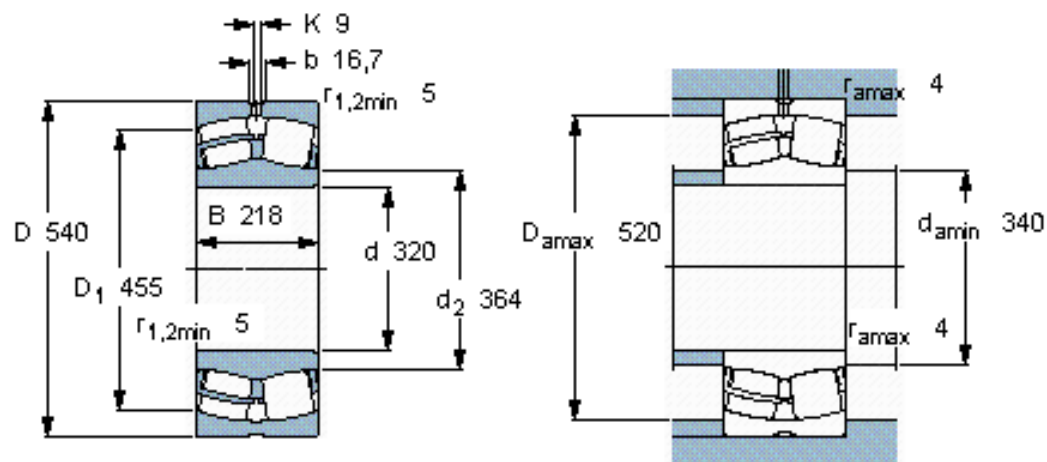

#### Calculation factors

$e = 0,40$   
 $Y_1 = 1,7$   
 $Y_2 = 2,5$   
 $Y_0 = 1,6$